

PA10 Series

Multifunctional sensor controller

■ Features

- 13 kinds of various operation modes selected by DIP switches
- High speed input response
- Flip-flop mode for level control
- Multifunctional unit with timer mode
- DIN rail, Mounting to panel
- Wide range of power supply(100-240VAC 50/60Hz)



⚠ Please read "Caution for your safety" in operation manual before using.

■ Ordering information

PA10	—	U		
Item	Function	Input	No mark	NPN input
			P	PNP input
Item	Function	Input	U	High function controller
			V	General purpose controller
			W	2-channel controller
Item			PA10	Power amplifier

■ Specifications

Model	PA10-U	PA10-V	PA10-VP	PA10-W	PA10-WP
Power supply	100-240VAC 50/60Hz				
Allowable operation voltage	90 to 110% of rated voltage				
Power consumption	100VAC 50/60Hz: Max. 9VA(Condotion:12VDC/200mA resistive load), 240VAC 50/60Hz: Max. 10VA				
Power for external sensor	12VDC ±10% Approx. 200mA				
Input(IN1)(IN2)	Selectable NORM/INV. Selectable OR/AND operation for IN1, IN2 input. Selection function for IN2 derivative action.		Selectable NORM/INV. Operation for IN1, IN2 AND.		Selectable NORM/INV. Operation for IN1, IN2 AND.
	NPN input type		NPN input type	PNP input type	NPN input type
Input type	<ul style="list-style-type: none"> • PA10-U(No-voltage input) Impedance at short-circuit: Max. 680Ω, Residual voltage at short-circuit: Max. 0.8V, Impedance at open: Min. 100kΩ • PA10-V/PA10-W(No-voltage input) Impedance at short-circuit: Max. 300Ω, Residual voltage at short-circuit: Max. 2V, Impedance at open: Min. 100kΩ • PA10-VP/PA10-WP(Voltage input) Input impedance: 5.6kΩ, "H" level voltage:5-30VDC, "L" level voltage: 0-2VDC 				
Output	Contact output	OUT : 250VAC 3A(resistive load)			OUT1, OUT2 : 250VAC 3A(resistive load)
	Solid-state output	O-C OUT1/O-C OUT2 : NPN open collector output Max. 30VDC 100mA	O-C OUT: NPN open collector output Max. 30VDC 100mA		—
Response time	Input : Min. 2μs, Relay contact output : Min. 10ms, Transistor output : Min. 0.5μs(When it is encoder mode)				
Time setting function by each mode ※Only for PA10-U	Have	<ul style="list-style-type: none"> • ON Delay Mode • One-Shot Delay Mode • Flicker One-Shot Mode • High-Speed Detection Mode 			<ul style="list-style-type: none"> • OFF Delay Mode • Flicker Mode • Low-Speed Detection Mode • ON/OFF Delay Mode
		None	• Normal Mode • Flip-Flop Mode • Encoder(Mode 9 to 11)		
Relay life cycle	Mechanical	Min. 10,000,000 operations			
	Electrical	Min. 100,000 operations(250VAC 3A resistive load)			
Dielectric strength	2000VAC 50/60Hz for 1 minute				
Insulation resistance	Min. 100MΩ(at 500VDC megger)				
Environment	Ambient temperature	-10 to 55°C, storage: -25 to 60°C			
	Ambient humidity	35 to 85%RH, storage: 35 to 85%RH			
Unit weight	Approx. 150g			Approx. 160g	

※If the load is connected over 200mA at the sensor output, it may cause mechanical trouble.

※Environment resistance is rated at no freezing or condensation.

Sensor Controller

Dimensions

(unit: mm)

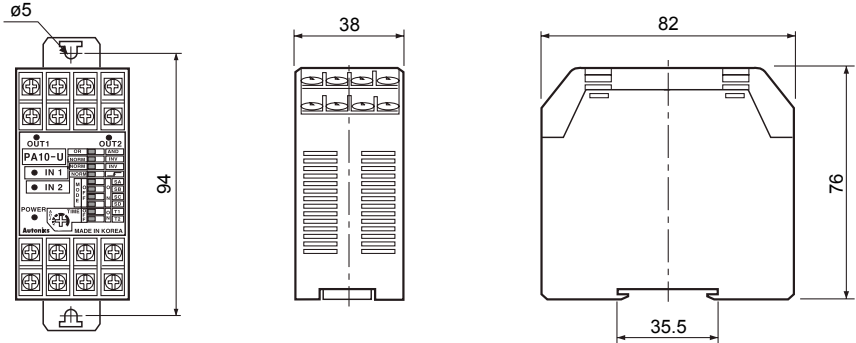

(A)	Photo electric sensor
(B)	Fiber optic sensor
(C)	Door/Area sensor
(D)	Proximity sensor
(E)	Pressure sensor
(F)	Rotary encoder
(G)	Connector/Socket
(H)	Temp. controller
(I)	SSR/ Power controller
(J)	Counter
(K)	Timer
(L)	Panel meter
(M)	Tacho/ Speed/ Pulse meter
(N)	Display unit
(O)	Sensor controller
(P)	Switching mode power supply
(Q)	Stepper motor& Driver&Controller
(R)	Graphic/ Logic panel
(S)	Field network device
(T)	Software
(U)	Other

Connections

PA10-U

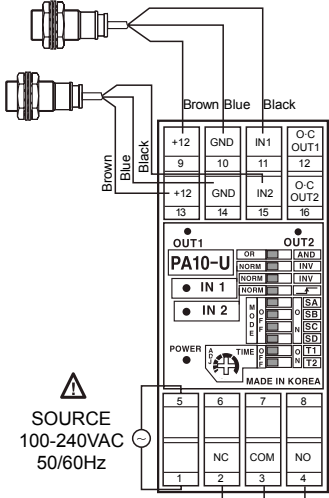

⚠ SOURCE
100-240VAC
50/60Hz

CONTACT OUT:
250VAC 3A
RESISTIVE LOAD

PA10-V/PA10-VP

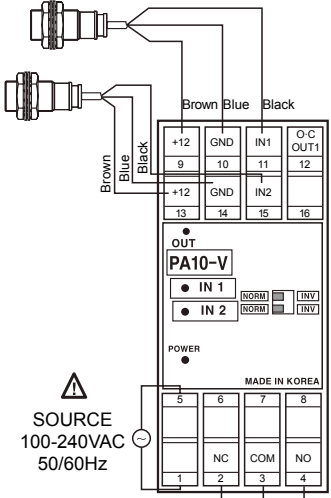

⚠ SOURCE
100-240VAC
50/60Hz

CONTACT OUT:
250VAC 3A
RESISTIVE LOAD

PA10-W/PA10-WP

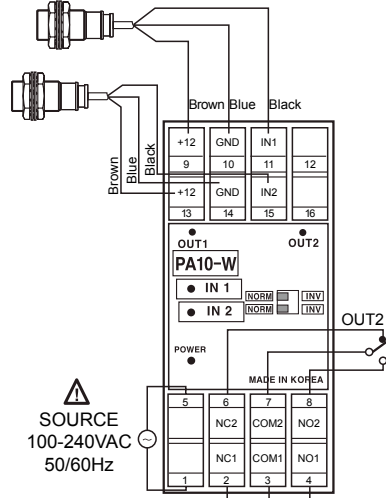

⚠ SOURCE
100-240VAC
50/60Hz

CONTACT OUT1,OUT2:
250VAC 3A
RESISTIVE LOAD

Input connections

PA10-U

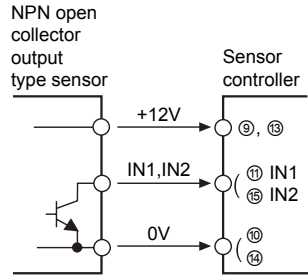

PA10-V / PA10-W

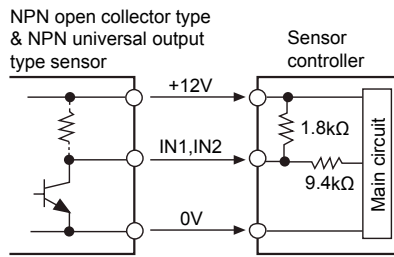

PA10-VP / PA10-WP

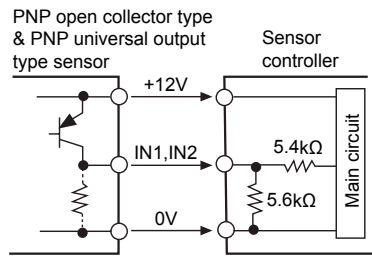

PA10 Series

Function diagram

PA10-U

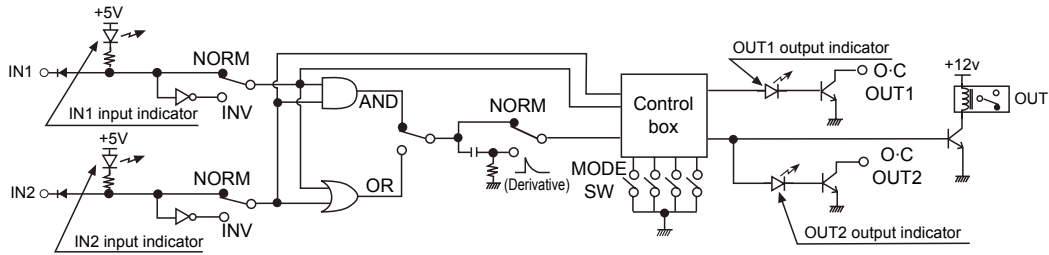

PA10-V PA10-VP

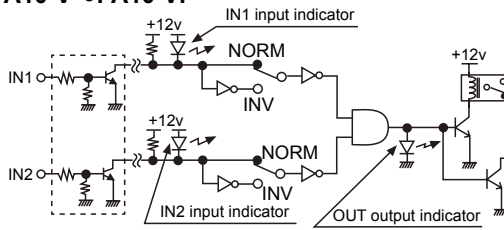

PA10-W PA10-WP

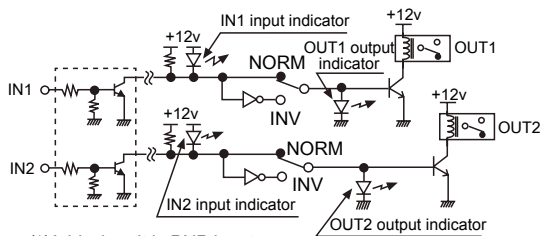

※Add when it is PNP input

※Add when it is PNP input

Front panel identification

PA10-U

- Power indicator :**
LED is turned on when AC power applied
- Output1 indicator :**
Indication of output 1 operation status
- Output2 indicator :**
Indication of output 2 operation status
- Sensor input indicator**
Indicates sensor input signal
(LED is turned on when sensor input is Low)
- AND/OR selection switch :**
Select "AND" or "OR" for IN1, IN2 Input
- Selection switch of sensor input signal**

NORM	INV
------	-----

 - NORM: LED is turned on when input signal is low. (\bar{L})
 - INV: LED is turned on when input signal is high. (\bar{H})
- Derivative action selection of IN2 input signal (OR/AND selection switch : AND)**

NORM	Derivative
------	------------

 - NORM: IN2 input signal is operating as reverse turn function
 - Derivative: IN2 Derivative action of IN2 input signal. (※Refer to O-7, Application of derivative operation,)

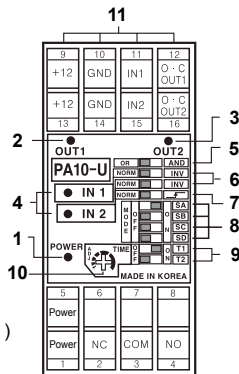

- Selection switch for operation mode :**
See <Operation mode> in next page.
- Selection switch of time range and max. input frequency :** It is the switch to select time range (1 to 7 mode) or allowable input frequency (9 to 11 mode).

0	1	T1
F	N	T2

 - Time range : Approx. 0.01 to 0.1sec. Max. input frequency : 100kHz
 - Time range : Approx. 0.1 to 1sec. Max. input frequency : 10kHz
 - Time range : Approx. 1 to 10sec. Max. input frequency : 1kHz
 - Time range : Approx. 10 to 100sec. Max. input frequency : 100Hz
- Timer adjuster**
Adjust time as same as the range of 9.
- Terminal block**

PA10-V/PA10-VP

- Power indicator :**
LED is turned on when AC power applied
- Output indicator :**
Indicates output operation
- Sensor input indicator :**
 - PA10-V : Indicates sensor input signal (LED turns on when sensor input is Low)
 - PA10-VP : Indicates sensor input signal (LED turns on when sensor input is High)
- Selection switch of sensor input signal**
 - NORM: When sensor input signal is Low, it is valid signal.
 - INV: When sensor input signal is High, it is valid signal.
- Terminal block**

※When IN1, IN2 input signal is AND, OUT will work.

PA10-W/PA10-WP

- Power indicator :**
LED is turned on when AC power applied
- Output1 indicator :**
Indication of output 1 operation status
- Output2 indicator :**
Indication of output 2 operation status
- Sensor input indicator :**
 - PA10-W : Indicates sensor input signal (LED is turned on when sensor input is Low)
 - PA10-WP : Indicates sensor input signal (LED is turned on when sensor input is High)
- Selection switch of sensor input signal**
 - NORM: When sensor input signal is Low, it is valid signal.
 - INV: When sensor input signal is High, it is valid signal.
- Terminal block**

※IN1, IN2 operates individually.

■ Operation mode(PA10-U)

● MODE 0 Normal mode

OUT will work according to input signal regardless Timer.

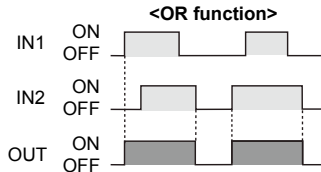

※Output will be ON when either IN1 or IN2 is ON.

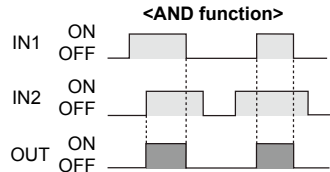

※ Output will be ON when both IN1 and IN2 are ON.

● MODE 1 ON-Delay mode

OUT will be ON after delayed as setting time according to one of IN1 and IN2 is ON. When IN1 and IN2 are OFF, OUT will be OFF.

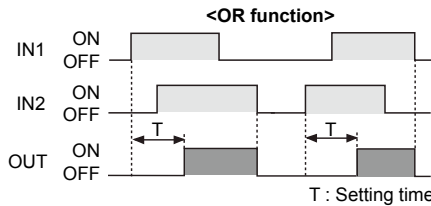

T : Setting time

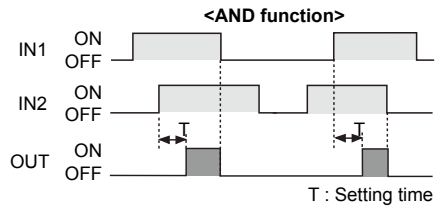

T : Setting time

● MODE 2 OFF-Delay mode

OUT will be ON at the same time when IN1 or IN2 is ON then OUT will be OFF after delayed as setting time according to IN1 or IN2 is OFF.

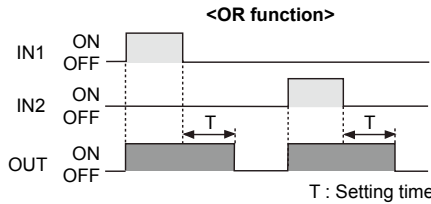

T : Setting time

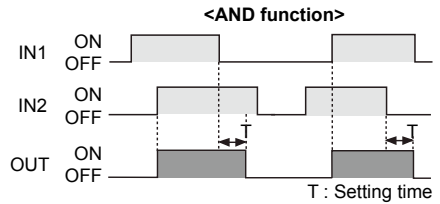

T : Setting time

● MODE 3 ONE-Shot delay mode

OUT will be ON at the same time with IN1 or IN2 is ON then OUT will be OFF after delayed as setting time.

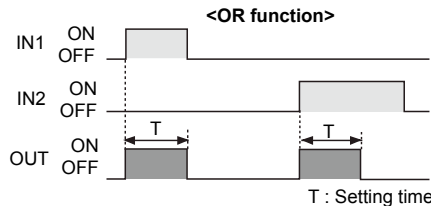

T : Setting time

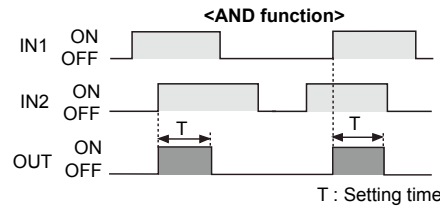

T : Setting time

● MODE 4, 5 Flicker mode / Flicker one-shot mode

OUT will be ON after delayed as setting time for IN1 input then it is flashing and OUT will be flashing after setting time from ON. But, in case of one-shot mode, output time(Ts) will be selected by NORM f.

(f) : Ts = Approx. 10ms, (NORM) : Ts = Approx. 100ms



(MODE 4)



(MODE 5)

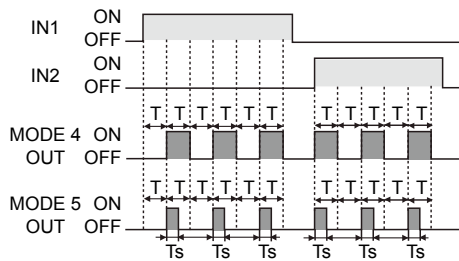

※T : Setting time, Ts : One-Shot output time

Note)ON/OFF ratio of flicker output is 1:1

Note)In case of flicker mode, it is not different between OR AND and NORM f.

Note)In case of one-shot mode, it is not different between OR AND .

- (A) Photo electric sensor
- (B) Fiber optic sensor
- (C) Door/Area sensor
- (D) Proximity sensor
- (E) Pressure sensor
- (F) Rotary encoder
- (G) Connector/ Socket
- (H) Temp. controller
- (I) SSR/ Power controller
- (J) Counter
- (K) Timer
- (L) Panel meter
- (M) Tacho/ Speed/ Pulse meter
- (N) Display unit
- (O) Sensor controller
- (P) Switching mode power supply
- (Q) Stepper motor& Driver&Controller
- (R) Graphic/ Logic panel
- (S) Field network device
- (T) Software
- (U) Other

PA10 Series

■ Operation mode(PA10-U)

● MODE 6 Low-speed detection mode

OUT will be ON when input signal(IN1) is longer than setting time by comparing it to the setting time by one cycle.

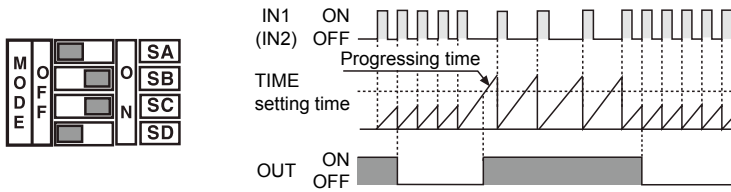

Note)Above is when input logic is OR and it will be the same by using IN2 input signal terminal instead of IN1.

Note)When use MODE 6 as above, be sure that OUT will be work at the same time with power supply.

● MODE 7 High-speed detection mode

OUT will be ON when input signal(IN1) is shorter than setting time by comparing it to the setting time by one cycle.

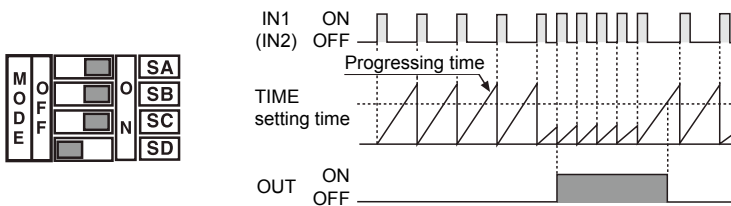

Note)Above is when input logic is OR and it will be the same by using IN2 input signal terminal instead of IN1.

◎ Time switches(MODE 1 to MODE 7)

Set the time by time switches(T1, T2) and front time adjuster(ADJ).

MODE TIME S/W	MODE OFF	O N	SA SB SC SD	MODE	MODE 1 to MODE 7, MODE 12	MODE 6 to MODE 7	
				Item	Setting time range	Input frequency	rpm
				T1 T2	0.01 to 0.1sec	100 to 10Hz	6,000 to 600rpm
				T1 T2	0.1 to 1sec	10 to 1Hz	600 to 60rpm
				T1 T2	1 to 10sec	1 to 0.1Hz	60 to 6rpm
				T1 T2	10 to 100sec	0.1 to 0.01Hz	6 to 0.6rpm

※Range of operating rpm is 1 pulse per 1 revolution.

※When the pulse is increasing per 1 revolution, range of operating rpm is decreasing.

● MODE 8 Flip-Flop mode [OUT latch operation]

When IN1 signal is input then the Flip-Flop output will be ON(SET). When the IN2 signal is input, Flip-Flop Signal will be OFF(RESET).

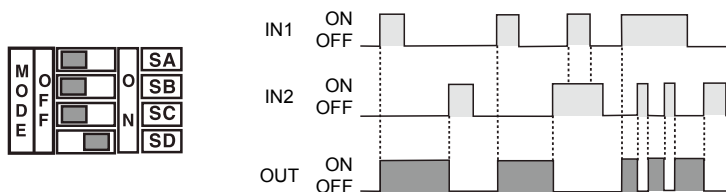

Note)IN2 will be prior to all input signal.

Note)Both and switches are allowed to use.

Note)There is no Timer function in Flip-Flop Mode, therefore use this unit with time switches(T1, T2) are OFF.

■ Operation mode(PA10-U)

◎ Encoder mode (MODE 9 to MODE 11)

- 1) There should be 90° phase difference between IN1 and IN2 for input terminal.
- 2) Please connect A phase output of encoder to IN1 and B phase output of encoder to IN2, when use NPN open collector or totem pole output type of encoder with PA10-U. In this case, detection signal(O.C OUT2) output of PA10-U will be OFF when turning encoder to CW direction.
- 3) There are output function of pulse(O.C OUT1) has been multiplied($\times 1$, $\times 2$, $\times 4$ times) against input signal and Direction detection output(O.C OUT2) function which detects direction of encoder revolution in Encoder mode.
- 4) Be cautious about input speed(cps) of connected equipment due to pulse width of O.C OUT1 is short.
- 5) OR AND NORM INV Selection switches can be set at any position.

● MODE 9 ENCODER (Input pulse $\times 1$ time)



● MODE 10 ENCODER (Input pulse $\times 2$ times)



● MODE 11 ENCODER (Input pulse $\times 4$ times)

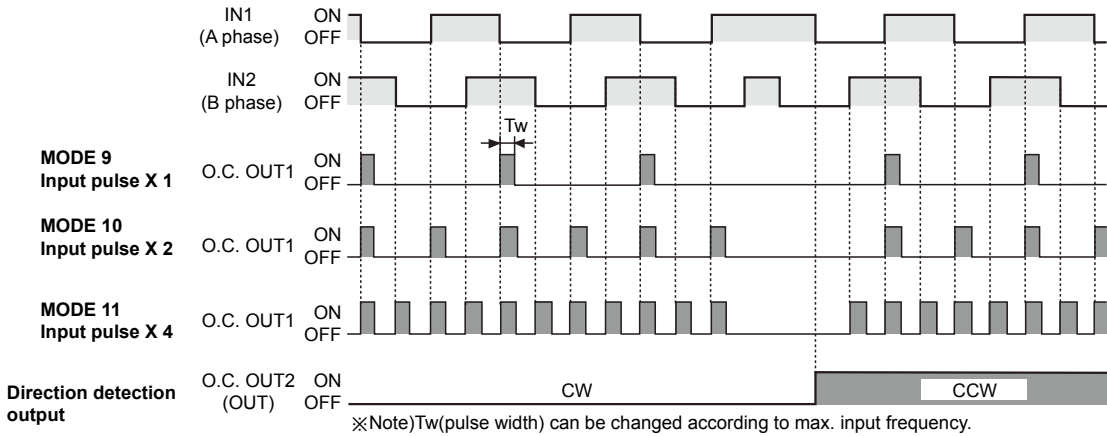

◎ Time switches in encoder mode

Time switch is to convert output pulse width(T_w).

Time switch	Max. input frequency	Output pulse width(T_w)	Input speed of connected equipment(cps)
<input type="checkbox"/> OFF <input type="checkbox"/> ON <input type="checkbox"/> T1 <input type="checkbox"/> T2	100kHz	Approx. 0.5 μ s	Min. 2000kHz(2,000kcps)
<input type="checkbox"/> OFF <input type="checkbox"/> ON <input type="checkbox"/> T1 <input type="checkbox"/> T2	10kHz	Approx. 5 μ s	Min. 200kHz(200kcps)
<input type="checkbox"/> OFF <input type="checkbox"/> ON <input type="checkbox"/> T1 <input type="checkbox"/> T2	1kHz	Approx. 50 μ s	Min. 20kHz(20kcps)
<input type="checkbox"/> OFF <input type="checkbox"/> ON <input type="checkbox"/> T1 <input type="checkbox"/> T2	100Hz	Approx. 500 μ s	Min. 2kHz(2kcps)

● MODE 12 ON/OFF-DELAY MODE

OUT will be ON after setting time when IN1(or IN2) is ON. When IN1(or IN2) is OFF, OUT will be OFF after setting time. (This is when input logic is OR)

※If IN1(or IN2) ON/OFF time is shorter than setting time, OUT does not turn.

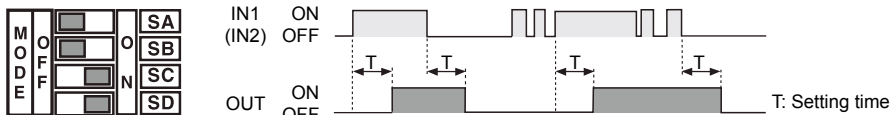

- (A) Photo electric sensor
- (B) Fiber optic sensor
- (C) Door/Area sensor
- (D) Proximity sensor
- (E) Pressure sensor
- (F) Rotary encoder
- (G) Connector/ Socket
- (H) Temp. controller
- (I) SSR/ Power controller
- (J) Counter
- (K) Timer
- (L) Panel meter
- (M) Tacho/ Speed/ Pulse meter
- (N) Display unit
- (O) Sensor controller
- (P) Switching mode power supply
- (Q) Stepper motor& Driver&Controller
- (R) Graphic/ Logic panel
- (S) Field network device
- (T) Software
- (U) Other

PA10 Series

Application of derivative operation

Sensing labels of glass bottles

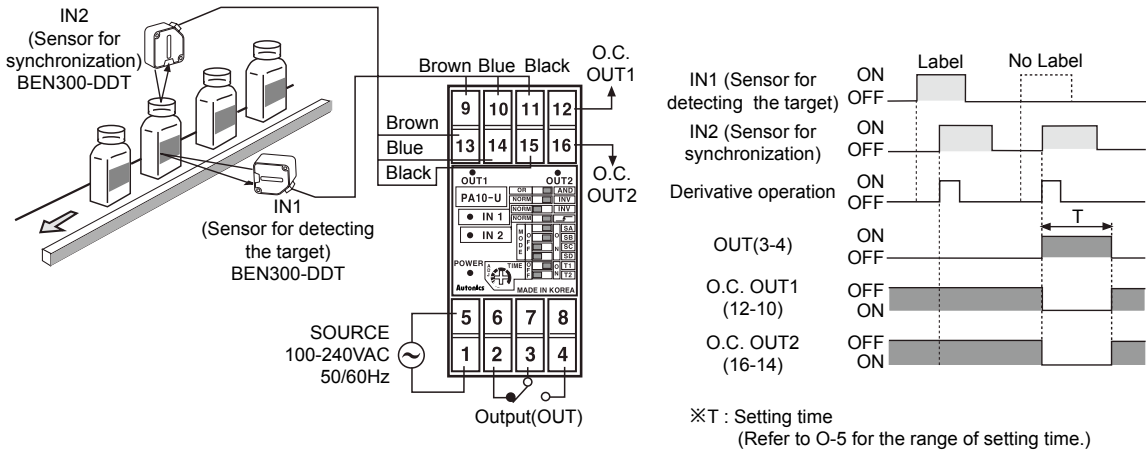

Operation

When IN2 is ON after IN1 is ON, OUT will not operate. But if there is no label on bottle, OUT will operate with IN2 is ON only. OUT will be returned after setting time.

Note) Please install the sensor(IN1) to be operated first.

Factory default for S/W

● PA10-U:
MODE1 ON-DELAY

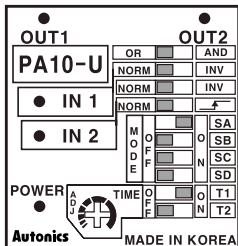

● PA10-V: NORM
● PA10-VP: NORM

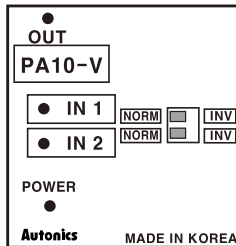

● PA10-W: NORM
● PA10-WP: NORM

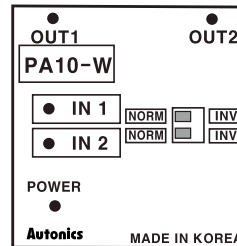

Proper usage

Load connections

It is important to protect from surge or noise by installing a surge absorber across inductive loads(Motor, solenoid, etc).

In case the load is a DC relay, please install a diode across relay as shown below.
(Be careful of polarity.)

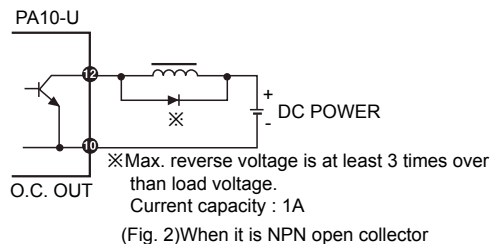
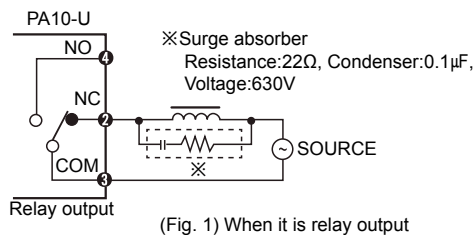

Input signal line

- Please make the cable line short from input sensor to this controller.
- Do not put input signal line with other power cable in the same conduit.
- When need to extend the input signal line, please use shielded cable.

Ⓢ Precaution for installation

When it is required to install more than two PA10, the space between two PA10 should be larger than 10mm in order for proper cooling.

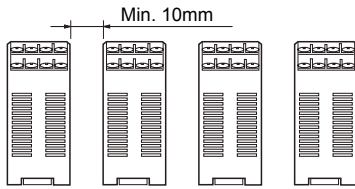

Ⓢ Other precautions

- Installation and dismantlement should be done with power off.
- Please check connections before wiring.
- Good ventilation must be considered to protect heating from inner components.
(Ambient operating temperature is -10°C to 55°C.)
- Do not supply over 100-240VAC.
- Do not install this controller at place where there are dust, steam, corrosive gas, water etc.
- AC power line must be separated from O.C output line or signal input line.
- This controller has been designed to have high speed response for O.C output. If use micro switch or limit switch for signal input, chattering might be occurred at O.C output.

(A)	Photo electric sensor
(B)	Fiber optic sensor
(C)	Door/Area sensor
(D)	Proximity sensor
(E)	Pressure sensor
(F)	Rotary encoder
(G)	Connector/ Socket
(H)	Temp. controller
(I)	SSR/ Power controller
(J)	Counter
(K)	Timer
(L)	Panel meter
(M)	Tacho/ Speed/ Pulse meter
(N)	Display unit
(O)	Sensor controller
(P)	Switching mode power supply
(Q)	Stepper motor& Driver&Controller
(R)	Graphic/ Logic panel
(S)	Field network device
(T)	Software
(U)	Other